

390ml/12oz Cold Paper BioCup BCC-12

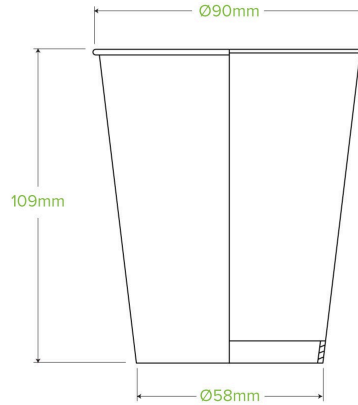

Carton quantity: 1000	Sleeves per carton: 20	Units per sleeve: 50
Carton Size LxWxH (cm): 46.0 x 37.0 x 50.0	Carton gross weight (kg): 11.800000	Carton barcode: 19344062012631
Raw material: Paper - FSC™ Mix certified paper	Lining/coating: Bioplastic - Ingeo®, PLA	Window material: None
Printing Type: Flexo	Inks: Food Contact Safe Inks	Brim fill capacity (ml): 400
Dimensions top LxW (mm): 89x89	Dimensions base LxW (mm): 58x58	Product Depth: 109.0
Product weight (g): 11.0	Thickness: 263gsm	Use: Hot and cold
Manufactured: China	Customise: Print	MOQ custom: 50000
Mould fees: Yes - see custom packaging	Environmental production certified: ISO 14001	Quality product certified: ISO 9001
Factory food safety certified: BRC	Corporate social accreditation: SA 8000, BSCI	Home compostable: No
Industrially compostable: Certified to AS4736 Australian Standards, Certified to EN13432 European Standard	Recyclable: No	